

Cabinet Furniture



Cabinet Knobs - CF1



Appliance/Cabinet Pulls - CF2



Flush Ring Pulls - CF3

Interchangeable Cabinet Knob & Rose Combinations

Our Cabinet Knobs are now offered in a choice of different Rosette combinations to provide complete design flexibility. This also affords the specifier the opportunity to mix finishes between Knob and Rosette to create a truly unique and individual piece.



0610 Polished Silver Knob on 0667ROSE in Antique Silver



	A	B	C	D
Diameter (all Rosettes except 0631)	Ø 19	Ø 25	Ø 32	Ø 38
0631 Diameter	Ø 25	Ø 32	Ø 38	-

How to Order

The Cabinet Knob and Rosette are ordered separately. Rosette codes are shown opposite, Cabinet Knob codes are shown throughout this section. Order the Rosette as follows:

- 1) select ROSETTE (e.g. 0645ROSE)
- 2) add FINISH (e.g. 0645ROSE/**PB**)
- 3) add SIZE (e.g. 0645ROSE/**PB/B**).

When ordering the Cabinet Knob, use Knob only code (eg. 0644, not 0645).

IMPORTANT - Please note that the Cabinet Knob and Rosette sizes must be the same (ie. a 32mm Cabinet Knob cannot be paired with a 25mm Rosette).

Finishes - See our price list or website for finish availability.

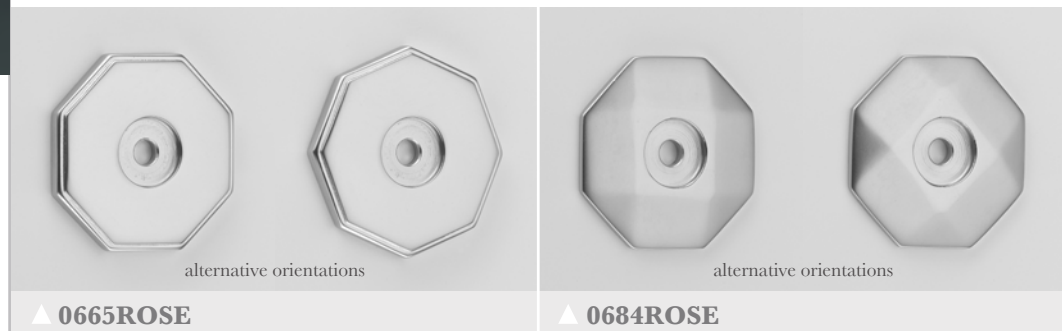

	A	B	C
Size (A/F)	25	32	38

A/F = dimension across flats

EXAMPLE

0644 Cabinet Knob shown with a selection of alternative Rosette combinations.

Cabinet Knobs

Four Cabinet Knob designs - in Smooth, Linear, Diamond and Square Mesh textures, each available in three sizes, with or without Rosette. Each knob & rosette is precision CNC machined for accuracy and consistent fine detailing. Designed to complement matching Allart Select Door Knobs in section ST2.



Fixings

Supplied with M4 x 50mm break-off flange head machine screws.



Dowel Screw option available

How to Order

- 1) select KNOB (e.g. **0701**)
 - 2) add FINISH (e.g. 0701**PB**)
 - 3) add SIZE (e.g. 0701**PB/B**).
- Choose DOWEL SCREW option if required (e.g. 0701**PB/B/DS**).

Finishes - See our price list or website for finish availability.



approx actual size B

▲ 0701



approx actual size B

▲ 0700



approx actual size B

▲ 0703



approx actual size B

▲ 0702



approx actual size B

▲ 0705



approx actual size B

▲ 0704



approx actual size B

▲ 0707



approx actual size B

▲ 0706

	A	B	C
D (diameter)	Ø 25	Ø 32	Ø 38
P (projection)	26	33	39
<i>p</i> (projection)	25	32	38

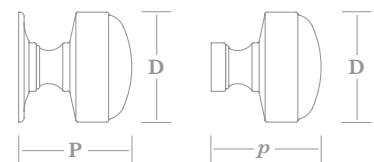

Cabinet Knobs

Two classic Cabinet Knobs, available in four sizes with or without Rosette, designed to complement both Allart Select and Traditional Door Knobs (see sections ST2 and DF2). Each knob & rosette is precision CNC machined for accuracy and consistent fine detailing.



▲ 0640



▲ 0641

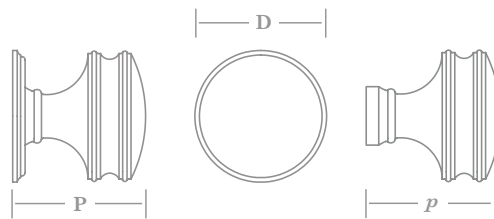

	A	B	C	D
D (dia)	Ø 19	Ø 25	Ø 32	Ø 38
p (proj)	19	24	31	36
P (proj)	20	25	32	37

Fixings

Supplied with M4 x 50mm break-off flange head machine screws.



Dowel Screw option available

How to Order

- 1) select KNOB (e.g. 0642)
- 2) add FINISH (e.g. 0642PB)
- 3) add SIZE (e.g. 0642PB/B).

Choose DOWEL SCREW option if required (e.g. 0642PB/B/DS).

Finishes - See our price list or website for finish availability.



▲ 0642



▲ 0643

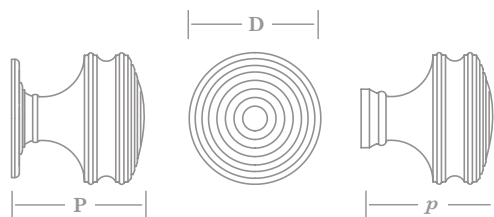

	A	B	C	D
D (dia)	Ø 19	Ø 25	Ø 32	Ø 38
p (proj)	19	24	31	36
P (proj)	20	26	33	37

Cabinet Knobs

Two traditional Cabinet Knobs, available in four sizes with or without Rosette, designed to complement both Allart Select and Traditional Door Knobs (see sections ST2 and DF2).

Each knob & rosette is precision CNC machined for accuracy and consistent fine detailing.



▲ 0644



▲ 0645

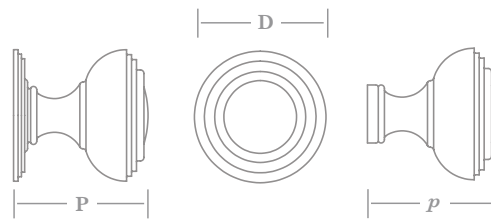

	A	B	C	D
D (dia)	Ø 19	Ø 25	Ø 32	Ø 38
p (proj)	19	24	31	36
P (proj)	20	26	33	37

Fixings

Supplied with M4 x 50mm break-off flange head machine screws.



How to Order

- 1) select KNOB (e.g. **0644**)
- 2) add FINISH (e.g. 0644**PB**)
- 3) add SIZE (e.g. 0644PB/**B**).

Choose DOWEL SCREW option if required (e.g. 0644PB/B/**DS**).

Finishes - See our price list or website for finish availability.



▲ 0646



▲ 0647

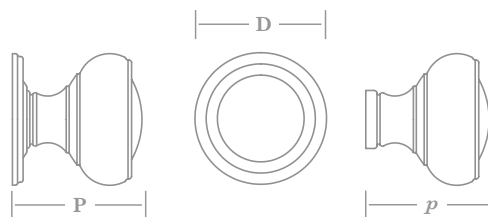

	A	B	C	D
D (dia)	Ø 19	Ø 25	Ø 32	Ø 38
p (proj)	19	24	30	36
P (proj)	20	26	31	37

Cabinet Knobs

Four contemporary Cabinet Knobs, each available in three sizes with or without Rosette. Each knob & rosette is precision CNC machined for accuracy and consistent fine detailing.



Fixings

Supplied with M4 x 50mm break-off flange head machine screws.



How to Order

- 1) select KNOB (e.g. **0631**)
 - 2) add FINISH (e.g. 0631**PB**)
 - 3) add SIZE (e.g. 0631PB/**B**).
- Choose DOWEL SCREW option if required (e.g. 0631PB/B/**DS**).

Finishes - See our price list or website for finish availability.



	A	B	C
D (diameter)	Ø 25	Ø 32	Ø 38
P (projection)	25	32	37
<i>p</i> (projection)	24	31	36

Cabinet Knobs

A selection of Cabinet Knobs available in various sizes, all designed to complement both Allart Select and Traditional Door Knobs (see sections ST2 and DF2).

Each knob & rosette is precision CNC machined for accuracy and consistent fine detailing.



approx actual size

▲ **0686** Ø 29 x 23 projection



approx actual size

▲ **0687** Ø 29 x 27 projection (rosette 32 Ø)



approx actual size D

▲ **0677**



approx actual size D

▲ **0678**



approx actual size C

▲ **0680**



approx actual size C

▲ **0685**

Fixings

Supplied with M4 x 50mm break-off flange head machine screws.



Dowel Screw option available

How to Order

- 1) select KNOB (e.g. **0680**)
- 2) add FINISH (e.g. 0680**PB**)
- 3) add SIZE (except 0686-7) (e.g. 0680**PB/B**).

Choose DOWEL SCREW option if required (e.g. 0680**PB/B/DS**).

Finishes - See our price list or website for finish availability.

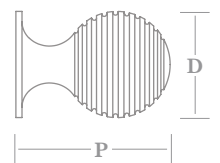
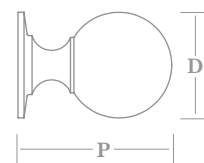
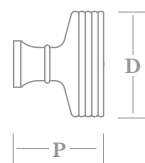
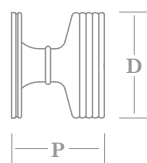

		A	B	C	D	E
	D (diameter)	Ø 19	Ø 25	Ø 32	Ø 38	Ø 44
0680/0685	P (projection)	27	37	46	55	64
0677	P (projection)	17	23	27	32	-
0678	P (projection)	18	24	28	33	-

Cabinet Knobs

Four Cabinet Knob designs, each available in four sizes with or without Rosette, which complement both Allart Select and Traditional Door Knobs (see sections ST2 and DF2). Each knob & rosette is precision CNC machined for accuracy and consistent fine detailing.



Fixings

Supplied with M4 x 50mm break-off flange head machine screws.



How to Order

- 1) select KNOB (e.g. **9176**)
 - 2) add FINISH (e.g. 9176**PB**)
 - 3) add SIZE (e.g. 9176PB/**B**).
- Choose DOWEL SCREW option if required (e.g. 9176PB/B/**DS**).

Finishes - See our price list or website for finish availability.



▲ 9176



▲ 9174



▲ 9177



▲ 9171



▲ 9178



▲ 9172



▲ 9179 (not available in size A)



▲ 9173 (not available in size A)

	A	B	C	D
D (diameter)	Ø 16	Ø 25	Ø 32	Ø 38
P (projection)	16	25	32	38
<i>p</i> (projection)	14	23	28	34



Cabinet Knobs

Three classic Cabinet Knobs, each available in four sizes with or without Rosette, designed to complement both Allart Select and Traditional Door Knobs (see sections ST2 and DF2). Each knob & rosette is precision CNC machined for accuracy and consistent fine detailing.



▲ 0693



▲ 0692



▲ 0695



▲ 0694



▲ 0697



▲ 0696

Fixings

Supplied with M4 x 50mm break-off flange head machine screws.



Dowel Screw option available

How to Order

- 1) select KNOB (e.g. **0697**)
 - 2) add FINISH (e.g. 0697**PB**)
 - 3) add SIZE (e.g. 0697PB/**B**).
- Choose DOWEL SCREW option if required (e.g. 0697PB/B/**DS**).

Finishes - See our price list or website for finish availability.

0692-0697	A	B	C	D
D (diameter)	Ø 19	Ø 25	Ø 32	Ø 38
P (projection)	20	24	30	36
<i>p</i> (projection)	19	23	29	35



Cabinet Knobs

A selection of Art Deco period Cabinet Knobs, all produced from hot brass stampings. Available in various sizes, designed to complement both Allart Select and Traditional Door Knobs (see sections ST2 and DF2).



▲ 9598



▲ 9596

	Knob size	Plate size	P (projection)
9596 A	32 x 16	-	25
B	38 x 19	-	27
9598	38 x 19	40 x 20	30

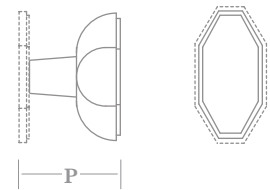

▲ 9590



▲ 9591



▲ 9592



▲ 9593

Fixings

Supplied with M4 x 50mm break-off flange head machine screws.



Dowel Screw option available

How to Order

- 1) select KNOB (e.g. 9596)
 - 2) add FINISH (e.g. 9596PC)
 - 3) add SIZE (except 9598) e.g. 9596PC/B.
- Choose DOWEL SCREW option if required (e.g. 9596PC/B/DS).

Finishes - See our price list or website for finish availability.

		Knob size	Plate size	P (projection)
9590 A	9592 A	19 x 12	Ø 19	17
B	B	25 x 16	Ø 25	22
C	C	32 x 20	Ø 32	28
D	D	38 x 24	Ø 38	33
9591 A	9593 A	19 x 12	-	16
B	B	25 x 16	-	21
C	C	32 x 20	-	27
D	D	38 x 24	-	32

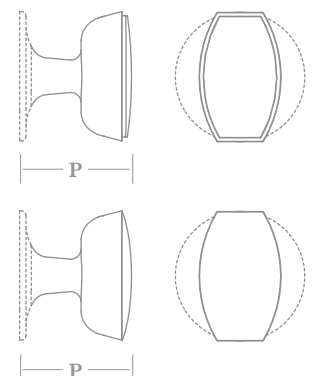

Cabinet Knobs

A selection of Cabinet Knobs available in various sizes, all designed to complement both Allart Select and Traditional Door Knobs (see sections ST2 and DF2).



▲ 0698



▲ 0699

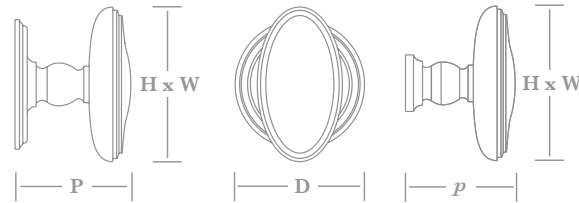

0698-9	A	B
H x W	30 x 16	38 x 21
D (dia)	Ø 25	Ø 32
p (proj)	23	28
P (proj)	24	29



▲ 0666



▲ 0667

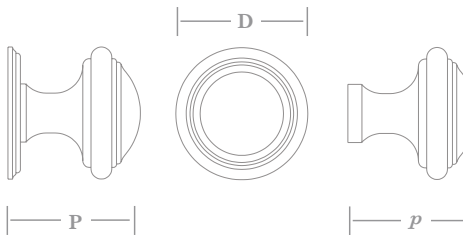

0666-7	A	B	C	D
D (dia)	Ø 19	Ø 25	Ø 32	Ø 38
p (proj)	19	24	31	38
P (proj)	20	25	32	39

Fixings

Supplied with M4 x 50mm break-off flange head machine screws.



Dowel Screw option available

How to Order

- 1) select KNOB (e.g. **0698**)
- 2) add FINISH (e.g. 0698**PB**)
- 3) add SIZE (e.g. 0698PB/**B**).

Choose DOWEL SCREW option if required (e.g. 0698PB/B/**DS**).

Finishes - See our price list or website for finish availability.



▲ 0664



▲ 0665

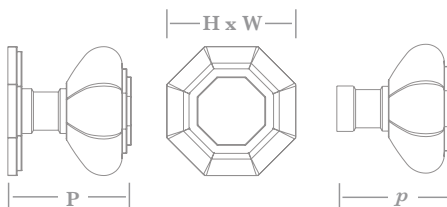

0664-5	A	B	C
H x W	25 x 25	32 x 32	38 x 38
p (proj)	23	29	35
P (proj)	24	31	37

Cabinet Knobs

A selection of contemporary Cabinet Knobs available in various sizes, designed to complement Allart Select Door Knobs (see section ST2).

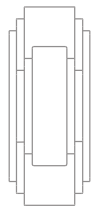
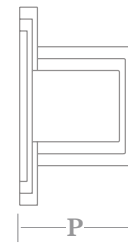
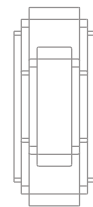
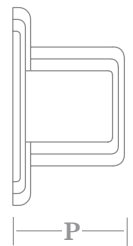
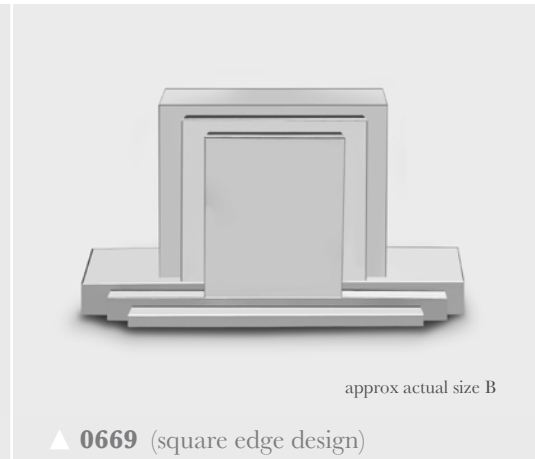
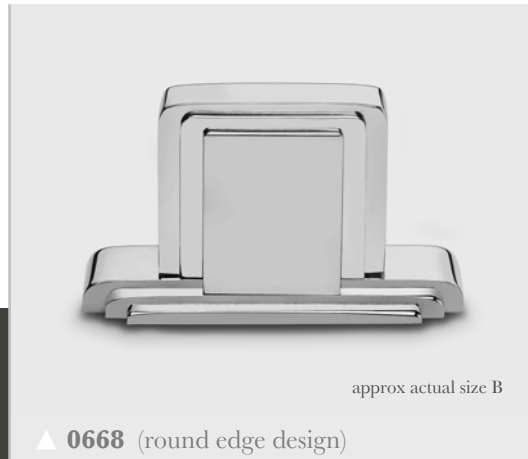
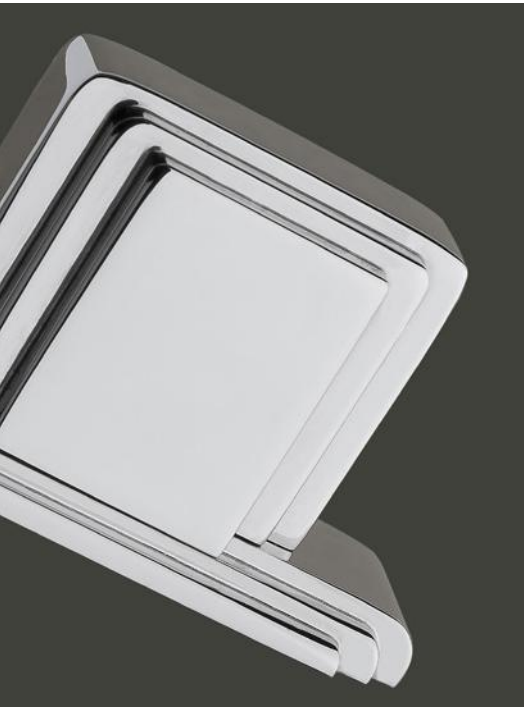

0668/9	Knob	Plate	P (proj)
A	25 x 13	40 x 16	24
B	30 x 17	50 x 21	28
C	37 x 19	60 x 23	34

Fixings

Supplied with M4 x 50mm break-off flange head machine screws.



How to Order

- 1) select KNOB (e.g. **0668**)
- 2) add FINISH (e.g. 0668**PB**)
- 3) add SIZE (e.g. 0668PB/**B**).

Choose DOWEL SCREW option if required (e.g. 0668PB/B/**DS**).

Finishes - See our price list or website for finish availability.

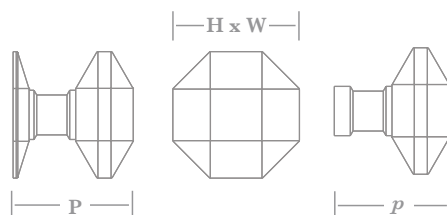

0683-4	A	B	C
H x W	25 x 25	32 x 32	38 x 38
p (proj)	21	27	33
P (proj)	23	29	35

Cabinet Knobs

A selection of contemporary Cabinet Knobs available in various sizes, designed to complement Allart Select Door Knobs (see section ST2).

The 0671 & 0672 are produced from hot brass stampings, whilst the other knobs are fully CNC machined.



approx actual size

▲ 0671



approx actual size

▲ 0672



approx actual size B

▲ 0675 (round edge design)



approx actual size B

▲ 0676 (square edge design)



approx actual size C

▲ 0690



approx actual size C

▲ 0691

Fixings

0671 & 0672 supplied with M6 x 40mm pan head machine screws. All others supplied with M4 x 50mm break-off flange head machine screws.



How to Order

- 1) select KNOB (e.g. 0671)
- 2) add FINISH (e.g. 0671PB)
- 3) add SIZE (except 0671-2) (e.g. 0690PB/B).

Choose DOWEL SCREW option if required (e.g. 0690PB/B/DS).

Finishes - See our price list or website for finish availability.



approx actual size C

▲ 0689

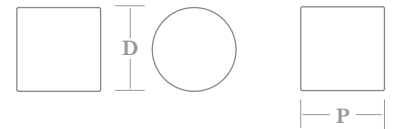

0689 / 0690 / 0691

0689/0690/0691	A	B	C	D
D (depth/diameter)	19	25	32	38
P (projection)	19	25	32	38

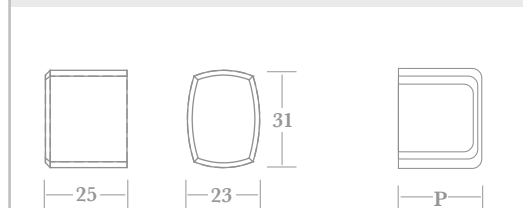

0671 / 0672

0675 / 0676

0675/6	Knob size	P (projection)
A	25 x 13	21
B	30 x 17	25
C	37 x 19	31

Cabinet Knobs - 32mm

Two Cabinet Knobs, Oval and Domed Oval designs, each available fitted to seven different 32mm diameter Rosettes which complement the Allart Select Door Knob & Lever Rosettes (see section ST3).

7210 Hand Burnished Brass Oval Knob on 7216ROSE Antique Brass Rosette



▲ 32mm Cabinet Knob (oval design)



Fixings

Supplied with M4 x 50mm break-off flange head machine screws.



How to Order

- 1) select KNOB (e.g. 7222)
 - 2) add FINISH (e.g. 7222PC).
- Choose DOWEL SCREW option if required (e.g. 7222PC/DS).

Finishes - See our price list or website for finish availability.



▲ 32mm Cabinet Knob (domed oval design)



Cabinet Knobs - 38mm

Two Cabinet Knobs, Oval and Domed Oval designs, each available fitted to seven different 38mm diameter Rosettes which complement the Allart Select Door Knob & Lever Rosettes (see section ST3).

7240 Oval Knob on 7242ROSE Rosette



▲ 38mm Cabinet Knob (oval design)



Fixings

Supplied with M4 x 50mm break-off flange head machine screws.



How to Order

- 1) select KNOB (e.g. 7232)
 - 2) add FINISH (e.g. 7232PC).
- Choose DOWEL SCREW option if required (e.g. 7232PC/DS).

Finishes - See our price list or website for finish availability.



▲ 38mm Cabinet Knob (domed oval design)



Cabinet Knobs

A selection of traditional Cabinet Knobs available in various sizes, all designed to complement both Allart Select and Traditional Door Knobs (see sections ST2 and DF2).

The 0670 & 0674 are fully CNC machined, whilst the other Oval and Domed Oval knobs are produced from hot brass stampings.



	A	B	C	D
D (diameter)	Ø 19	Ø 25	Ø 32	Ø 38
P (projection)	19	25	32	38

▲ 0670



	A	B	C
D (diameter)	Ø 25	Ø 32	Ø 38
P (projection)	25	32	38

▲ 0674



	A	B
H x W (height x width)	32 x 21	38 x 24
P (projection)	31	35

▲ 0681

▲ 0682



	A	B
H x W (height x width)	32 x 22	38 x 27
P (projection)	31	37
9169 plate size	38 x 38 x 4	38 x 38 x 4

▲ 9169

▲ 9168

Fixings

All except 0681 supplied with M4 x 50mm break-off flange head machine screws.



0681A supplied with finish matched no.4 x 13mm wood screws.

0681B supplied with finish matched no.6 x 19mm wood screws.

How to Order

- 1) select KNOB (e.g. **0682**)
- 2) add FINISH (e.g. 0682**PB**)
- 3) add SIZE (e.g. 0682PB/**B**).

Choose DOWEL SCREW option if required (e.g. 0682PB/B/**DS**).

Finishes - See our price list or website for finish availability.

Appliance Pulls

A selection of Pulls available in a variety of sizes to complement both traditional and modern interiors. They can also be found in the Door Furniture section (see DF3) where most are available fitted to back plates and many are offered in pairs for back-to-back installation.



Fixings

1433AA & 1433A supplied with finish matched no.6 x 19mm wood screws and M6 x 50mm machine screws (longer screws available upon request).

1433B & 1433C supplied as above, but with finish matched no.8 x 25mm wood screws.

1435AA & 1435A supplied with finish matched no.6 x 19mm wood screws.

1435B & 1435C supplied with finish matched no.8 x 25mm wood screws.

1434, 3934, 6999, 9512 & 9531 supplied with M6 x 50mm machine screws (longer screws available upon request).

4325 supplied with M8 x 50mm machine screws (longer screws available upon request).

How to Order

- 1) select HANDLE (e.g. **1435**)
 - 2) add FINISH (e.g. **1435PB**)
 - 3) add SIZE, except 3934 & 9531 (e.g. **1435PB/C**).
- 9531 only - add HANDLING (e.g. **9531PC/LH**).

Finishes - See our price list or website for finish availability.



▲ 3934



offset design, RH shown

▲ 9531



offset design

▲ 6999



▲ 4325



offset design

▲ 9512



offset design

▲ 1434

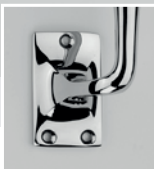

▲ 1435
(face fixed only)
1433
(face fixed & rear bolt fixing)

	Overall length	Centres	Proj
3934	245	159	58
9531	303	190	54
6999 A	240	216	62
B	270	245	62
4325 A	192	175	47
B	247	226	54
C	336	310	66

	Overall length	Centres	Proj
9512 A	210	190	40
B	254	232	46
1433-5 AA	158	116	42
A	203	152	54
B	254	191	61
C	305	234	68

Appliance Pulls

A classic Pull, available in three lengths and with twelve Rosette designs, each in up to three diameters, to complement the Allart Select Door Knob & Lever Rosettes (see section ST3) and the Cabinet Knobs shown on pages CF1:060 & 070.



size B Pull shown with 54mm Ø rosettes



These Pulls can also be found in the Door Furniture section (see DF3) available fitted to back plates and offered in pairs for back-to-back installation.

Fixings

Supplied with M8 x 50mm machine screws (longer screws available upon request).

How to Order

- 1) select HANDLE (e.g. 4358)
- 2) add FINISH (e.g. 4358PC)
- 3) add LENGTH (e.g. 4358PC/A)
- 4) add ROSETTE SIZE (e.g. 4358PC/A38).

Finishes - See our price list or website for finish availability.

▲ 4359

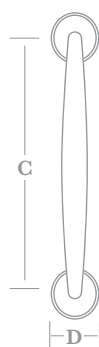

	C (centres)	Projection	D (diameter)
A	175	54	Ø 38
B	226	61	Ø 44, 54, 64
C	310	73	Ø 44, 54, 64

Appliance Pulls

A traditional Pull, available in two lengths and with eight Rosette designs, each in four diameters, to complement the Allart Select Door Knob & Lever Rosettes (see section ST3) and the Cabinet Knobs shown on pages CF1:060 & 070.



These Pulls can also be found in the Door Furniture section (see DF3) available fitted to back plates and offered in pairs for back-to-back installation.

Fixings

Supplied with M6 x 50mm machine screws (longer screws available upon request).

How to Order

- 1) select HANDLE (e.g. 1911)
- 2) add FINISH (e.g. 1911PC)
- 3) add LENGTH (e.g. 1911PC/A)
- 4) add ROSETTE SIZE (e.g. 1911PC/A44).

Finishes - See our price list or website for finish availability.



size A Pull shown with 54mm Ø rosettes

▲ 1911



▲ 1910



▲ 1911

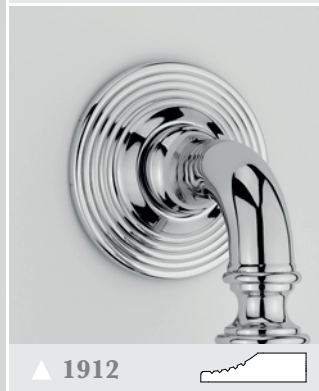

▲ 1912



▲ 1913

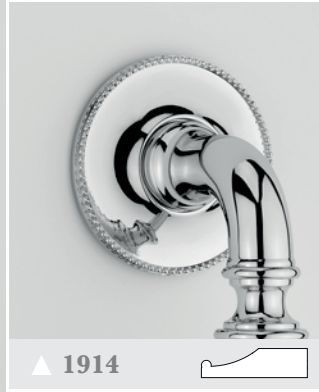

▲ 1914

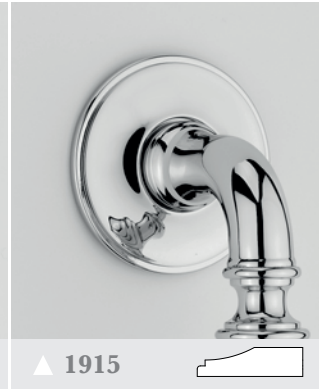

▲ 1915

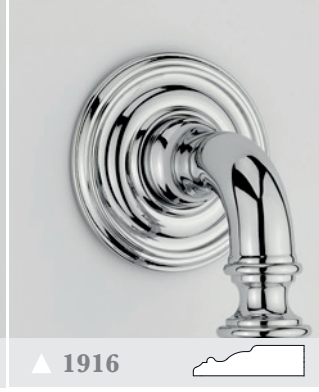

▲ 1916

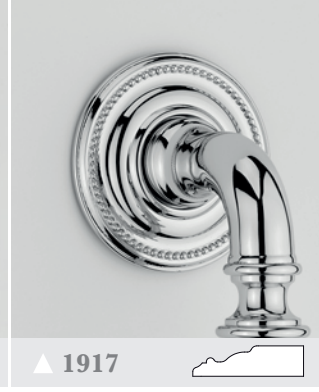

▲ 1917

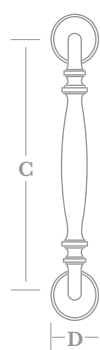

	C (centres)	Projection	D (diameter)
A	209	56	Ø 38, 44, 54, 64
B	241	56	Ø 38, 44, 54, 64

Appliance Pulls

A traditional offset design Pull, available in two lengths and with eight Rosette designs, each in four diameters, to complement the Allart Select Door Knob & Lever Rosettes (see section ST3) and the Cabinet Knobs shown on pages CF1:060 & 070.



These Pulls can also be found in the Door Furniture section (see DF3) available fitted to back plates and offered in pairs for back-to-back installation.

Fixings

Supplied with M6 x 50mm machine screws (longer screws available upon request).

How to Order

- 1) select HANDLE (e.g. **1986**)
- 2) add FINISH (e.g. **1986PC**)
- 3) add LENGTH (e.g. **1986PC/A**)
- 4) add ROSETTE SIZE (e.g. **1986PC/A44**).

Finishes - See our price list or website for finish availability.



size A Pull shown with 44mm Ø rosettes

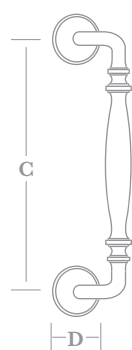

	C (centres)	Projection	D (diameter)
A	218	60	Ø 38, 44, 54, 64
B	250	60	Ø 38, 44, 54, 64

Bakes Pulls and Bakes Knobs

Classic Robert Bakes designed Pulls & Cabinet Knobs. The Pulls are available in five sizes from 130mm up to 375mm, whilst the Knobs are offered in two sizes.



▲ 0660

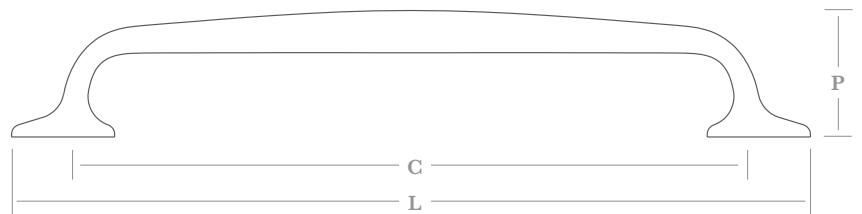

0660	A	B	C	D	E
L (length)	130	155	182	240	375
C (centres)	101	126	152	203	318
P (projection)	26	26	31	38	51

Fixings

0660A-D supplied with M4 x 50mm break-off machine screws (longer screws available upon request).

0660E supplied with M8 x 50mm machine screws (longer screws available upon request).

0661 supplied with M4 x 50mm break-off machine screws.



Dowel Screw option available

How to Order

0660 Pulls:

- 1) add FINISH (e.g. 0660PC)
- 2) add SIZE (e.g. 0660PC/A)

0661 Knobs:

- 1) add FINISH (e.g. 0661PC)
- 2) add SIZE (e.g. 0661PC/B)

Choose DOWEL SCREW option if required (e.g. 0661PC/B/DS).



▲ 0661



0661	A	B
H x W (height x width)	33 x 46	38 x 53
P (projection)	31	35

Finishes - See our price list or website for finish availability.

Cabinet Pulls

A traditional design Cabinet Pull available in three sizes, and three Art Deco design offset Cabinet Pulls to complement the 9512 Appliance Pulls shown on page CF2:010 and the Cabinet Knobs shown on page CF1:040.

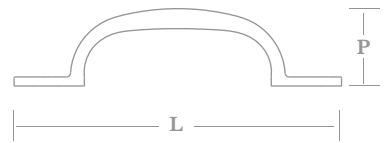

	A	B	C
L (length)	102	127	152
P (projection)	28	30	36

▲ 1436



▲ 9502 rear bolt fix



▲ 9503 rear bolt fix



▲ 9504 face fixed

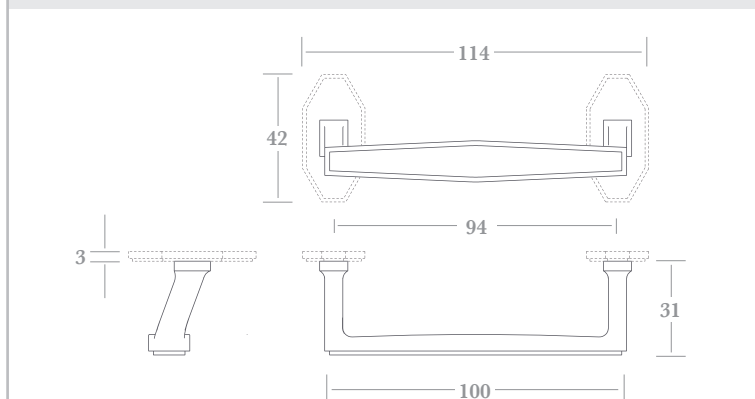

Fixings

9502 & 9503 supplied with M4 x 50mm break-off machine screws.

1436 & 9504 supplied with finish matched no.6 x 19mm wood screws.

How to Order

- 1) select HANDLE (e.g. 9503)
 - 2) add FINISH (e.g. 9503PC).
- 1436 only - add SIZE (e.g. 1436PC/A).

Finishes - See our price list or website for finish availability.

Flush Catch

A spring loaded Flush Catch with Angle Strike Plate.



▲ 1025 Flush Catch

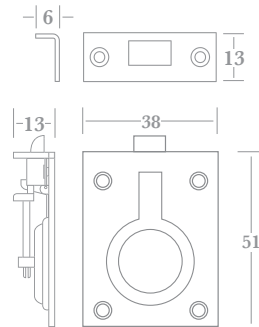
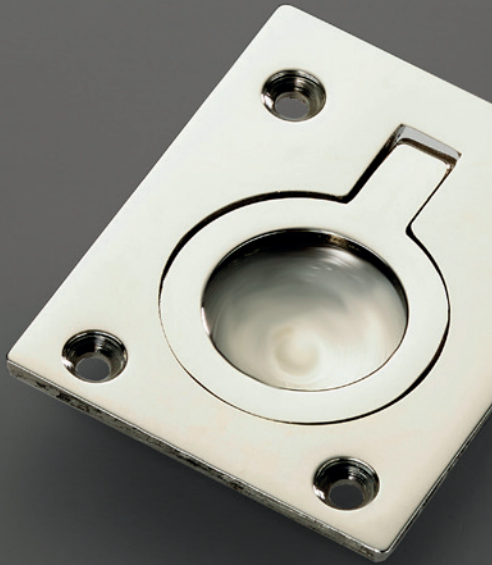

Fixings

Supplied with finish matched no.4 x 13mm wood screws.

How to Order

- 1) select PRODUCT (e.g. **1025**)
- 2) add FINISH (e.g. 1025**PB**).

Finishes - See our price list or website for finish availability.