

Miscellaneous



Door Holders & Door Stops - MC1



Hooks & Brackets - MC2



Locks, Latches & Bolts - MC3



Door Hinges - MC4

Fasteners, Screws & Components - MC5

Door Holders

The 2108 Door Holder Loop Plate is generally fitted towards the top of a door, with the Hook Plate fitted to the wall.

The design of the Hook is such that the mechanism is self latching with manual release.

The 2117 Door Stop/Holder incorporates a spring loaded plunger to automatically hold the door open. Supplied with two finish matched door edge protection plates.



▲ 2108

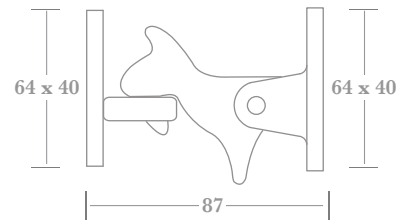

▲ 2117

Fixings

2108 supplied with finish matched no.8 x 25mm wood screws.

2117 supplied with finish matched no.6 x 25mm wood screws.

How to Order

- 1) select PRODUCT (e.g. **2108**)
- 2) add FINISH (e.g. 2108**SC**).

Finishes - See our price list or website for finish availability.

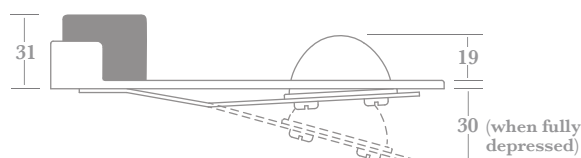
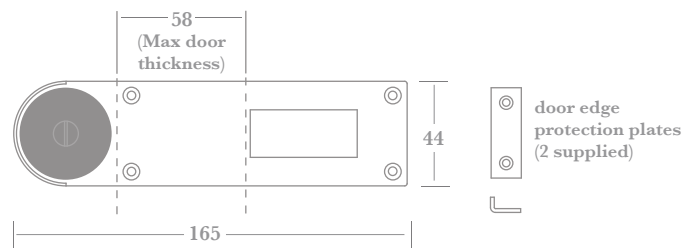

Door Stops - Wall Mounted

Four designs of Wall/Skirting Mounted Door Stops, three of which are available in two lengths; with custom lengths available upon request on the 2119 & 2120.

The 2119 & 2120 have removable Rubber Stops for fixing screw access. The 2125 pillar unscrews to expose fixing screw position.



▲ 2119

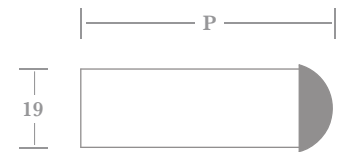

	A	B
P (projection)	61	74

other lengths available upon request



▲ 2120

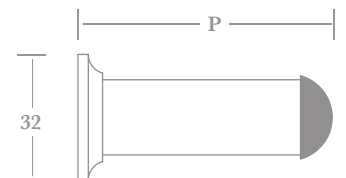

	A	B
P (projection)	64	77

other lengths available upon request



▲ 2125

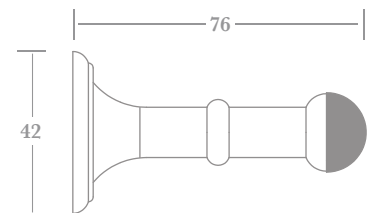

Fixings

2119 & 2120 supplied with no.12 x 38mm wood screws.

2125 supplied with 5mm x 30mm wood screw.

2126 supplied with finish matched no.6 x 19mm wood screws.

How to Order

1) select STOP (e.g. **2126**)

2) add FINISH (e.g. 2126**PC**)

2119, 2120 & 2126 only - add SIZE (e.g. 2126**PC/A**).

Finishes - See our price list or website for finish availability.



▲ 2126

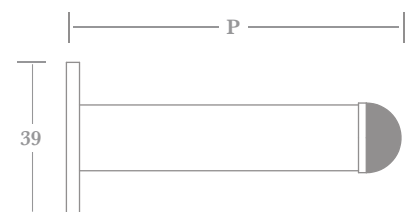

	A	B
P (projection)	86	113

Door Stops - Wall Mounted

Three designs of Wall/Skirting Mounted Door Stops with the 2118 available in three lengths. The 2111 is designed to be wall mounted at handle height to protect the wall surface from damage in a situation where a skirting stop cannot be used (e.g. hospital corridor).

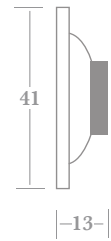

▲ 2111

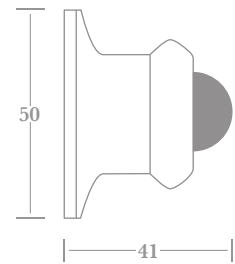

▲ 2115

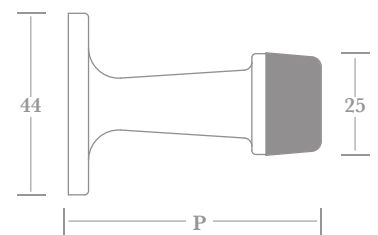

2118	A	B	C
P (projection)	51	63	76

▲ 2118

Fixings

2111 supplied with finish matched no.4 x 13mm wood screws.

2115 supplied with finish matched no.6 x 19mm wood screws.

2118 supplied with finish matched no.6 x 19mm wood screws.

How to Order

1) select STOP (e.g. **2118**)

2) add FINISH (e.g. 2118**PB**)

2118 only - add SIZE (e.g. 2118**PB/B**).

Finishes - See our price list or website for finish availability.

Door Stops - Floor Fixed

A selection of six Floor Fixed Door Stops, featuring a regular sized Oval Shielded Door Stop (2112), along with two taller versions (2114 & 2122) to cater for thick pile carpets and stepped thresholds.

The 2123 'Periscope' Door Stop is a stylish choice which transforms the humble door stop into a design statement.

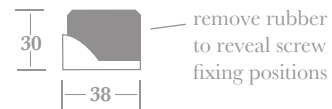
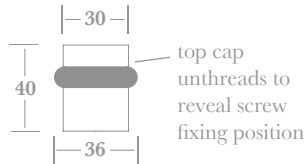
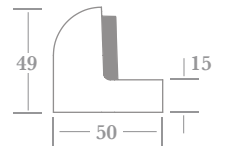
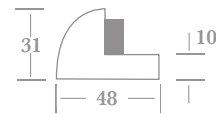
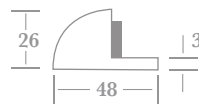

Fixings

2112, 2114 & 2123 supplied with finish matched no.8 x 25mm wood screws and anti-rotation pins.

2122 supplied with finish matched no.8 x 38mm wood screws.

2089 supplied with no.6 x 19mm wood screws and a black centre bolt to secure the rubber stop.

2130 supplied with no.12 x 38mm wood screw

How to Order

- 1) select STOP (e.g. **2112**)
- 2) add FINISH (e.g. 2112**PB**).

Finishes - See our price list or website for finish availability.

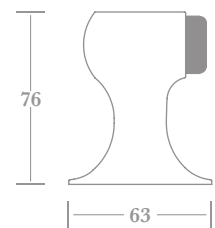

Coat Hooks

An Art Deco design of Hat & Coat Hook (9554) along with a complementary Robe Hook (9552).

The 2651 Multiple Coat Hook is ideal for use in restaurants, cocktail bars and pubs.



▲ 9554

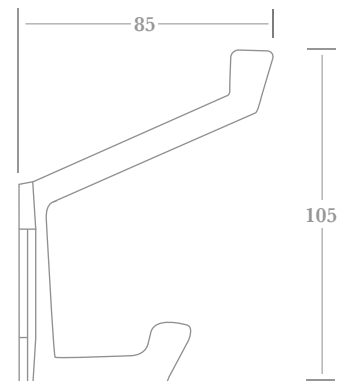

▲ 9552

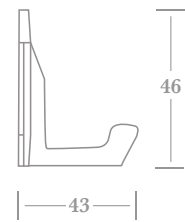

Fixings

9552 & 9554 supplied with finish matched no.6 x 19mm wood screws.

2651 supplied with finish matched no.8 x 25mm wood screws.

How to Order

- 1) select HOOK (e.g. 9552)
- 2) add FINISH (e.g. 9552PC).

Finishes - See our price list or website for finish availability.



▲ 2651

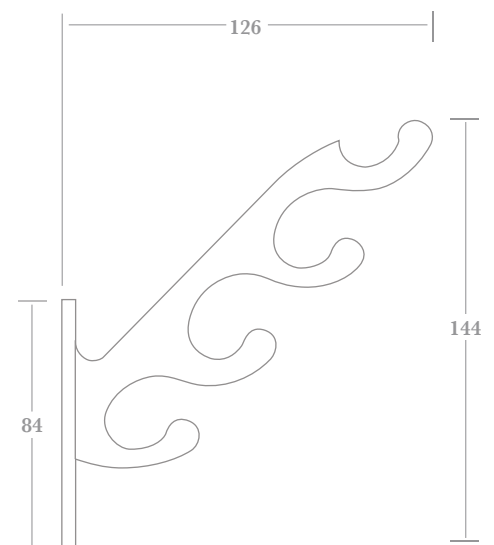

Coat Hooks

Two designs of Hat & Coat Hook - oval & square backed, along with two Robe Hooks.

The oval backed Hat & Coat Hook (1279) is available in two sizes.

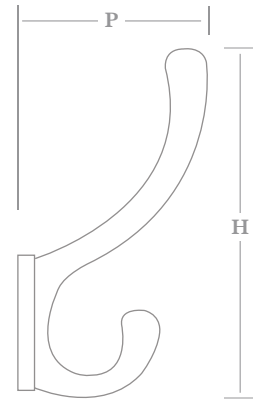

	A	B
P (projection)	55	75
H (height)	115	135

▲ 1279

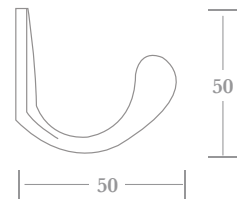
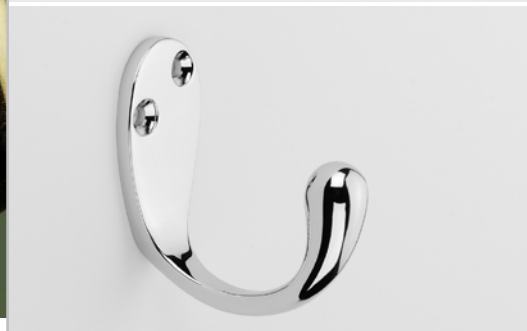

▲ 1286

Fixings

Supplied with finish matched no.6 x 19mm wood screws.

How to Order

- 1) select HOOK (e.g. 1279)
- 2) add FINISH (e.g. 1279PB)
- 1279 only - add SIZE (e.g. 1279PB/A).

Finishes - See our price list or website for finish availability.

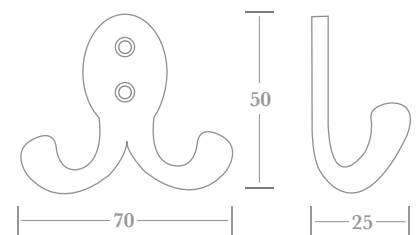

▲ 1301

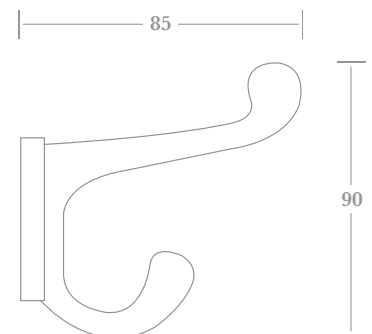

▲ 1319

Handrail Brackets & Cabin Hooks

A traditional design Handrail Bracket available in two sizes, along with two designs of Cabin Hook each available in a variety of lengths. The 0476 is also available in custom lengths if required.

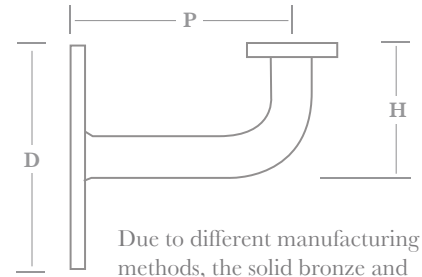

Due to different manufacturing methods, the solid bronze and brass versions vary dimensionally as shown below.

	Plate Diameter (D)		Projection (P)		Height (H)	
A	60	51	64	64	44	52
B	64	51	75	76	40	52

▲ 3189



▲ 0476

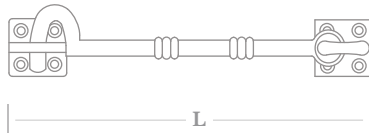

	A	B	C	D	E	F	G
L (length)	—	76	102	152	203	254	305
Plate size	30 x 30			40 x 40			

other lengths available upon request

Fixings

3189 supplied with finish matched no.8 x 25mm wood screws for rail fixing and finish matched no.8 x 38mm wood screws for base fixing.

0474 all sizes and 0476 B & C supplied with finish matched no.6 x 19mm wood screws.

0476D supplied with finish matched no.6 x 32mm wood screws.

0476E, F & G supplied with finish matched no.8 x 25mm wood screws.

How to Order

- 1) select PRODUCT (e.g. **0476**)
- 2) add FINISH (e.g. **0476PB**)
- 3) add SIZE (e.g. **0476PB/E**).

Finishes - See our price list or website for finish availability.



▲ 0474

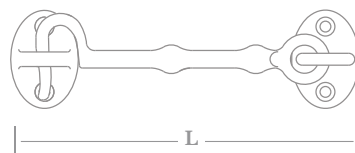

	A	B	C	D
L (length)	51	76	102	152
Plate size	32 x 22		36 x 25	

Passage Latch

A Passage Latch available with two latch spring strengths - 'light' for unsprung regular Knob Sets & sprung Lever Sets, and 'heavy' for unsprung Lever Sets & unsprung heavy Knob Sets, featuring a traditional handed Strike Plate supplied with a matt black Dust Box.

Strike & Face Plates along with cut head screws are supplied fully finish matched.



7521 shown

▲ **7520/7521 Latch & Strike Set**

Light spring two-way action for unsprung regular Knob Sets & sprung Lever Sets.

7524/7525 Latch & Strike Set

Heavy spring single action for unsprung Lever Sets & unsprung heavy Knob Sets.

Fixings

Lock Case supplied with no.6 x 25mm zinc plated steel wood screws. Lock Case Face Plate supplied with M4 x 6mm finish matched machine screws. Strike Plate supplied with finish matched no.6 x 38mm wood screws.

Fixing packs available to be ordered separately - use code 01/026 (add finish)

How to Order

Latch & Strike Set:

- 1) select LATCH SET (e.g. **7520**)
- 2) add FINISH (e.g. **7520PC**)

Strike Plate only:

- 7521STRIKE** - for 7521 & 7525
7520STRIKE - for 7520 & 7524

- 1) select STRIKE (e.g. **7520STRIKE**)
- 2) add FINISH (e.g. **7520STRIKE/PC**)

Finishes - See our price list or website for finish availability.

NB. Latch supplied in satin brass & dust box supplied matt black.

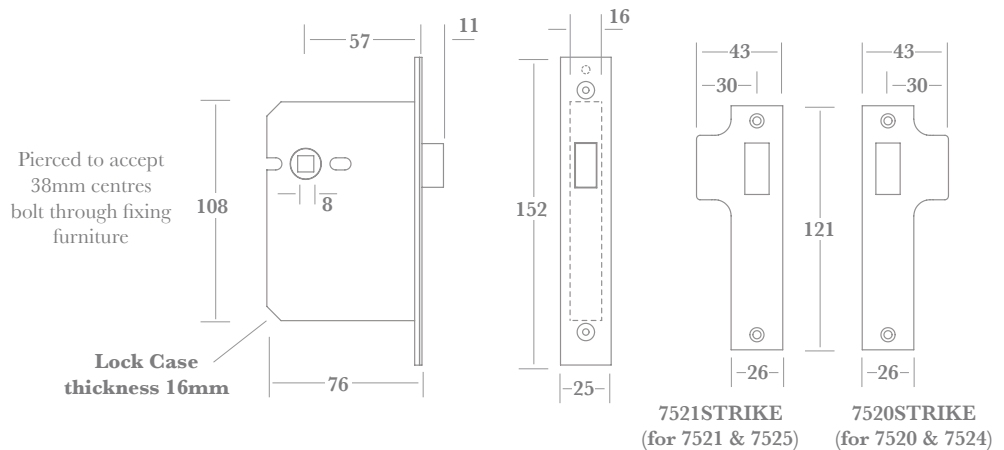

UK Specification	HANDING	CODE	ACTION
	LEFT	7520	light spring double action
	RIGHT	7521	light spring double action
	LEFT	7524	heavy spring single action
	RIGHT	7525	heavy spring single action

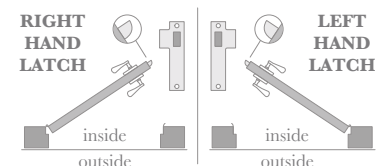

USA Specification	HANDING	CODE	ACTION
	RIGHT	7520	light spring double action
	LEFT	7521	light spring double action
	RIGHT	7524	heavy spring single action
	LEFT	7525	heavy spring single action

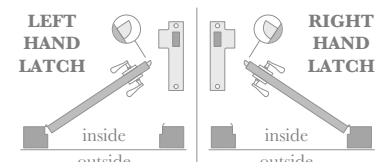

Privacy Lock

A Privacy Lock available with two latch spring strengths - 'light' for unsprung regular Knob Sets & sprung Lever Sets, and 'heavy' for unsprung Lever Sets & unsprung heavy Knob Sets, featuring a traditional handed Strike Plate supplied with a matt black Dust Box. Strike & Face Plates along with cut head screws are supplied fully finish matched.

A universal hub caters for either square or diamond orientated Turn spindles.



7531 shown

▲ 7530/7531 Lock & Strike Set

Light spring two-way action for unsprung regular Knob Sets & sprung Lever Sets.

7534/7535 Lock & Strike Set

Heavy spring single action for unsprung Lever Sets & unsprung heavy Knob Sets.

Fixings

Lock Case supplied with no.6 x 25mm zinc plated steel wood screws. Lock Case Face Plate supplied with M4 x 6mm finish matched machine screws. Strike Plate supplied with finish matched no.6 x 38mm wood screws. Fixing packs available to be ordered separately - use code 01/026 (add finish)

How to Order

Lock & Strike Set:

- 1) select LOCK SET (e.g. **7530**)
- 2) add FINISH (e.g. **7530PC**)

Strike Plate only:

7531STRIKE - for 7531 & 7535
7530STRIKE - for 7530 & 7534

- 1) select STRIKE (e.g. **7530STRIKE**)
- 2) add FINISH (e.g. **7530STRIKE/PC**)

Finishes - See our price list or website for finish availability.

NB. Latch and Dead Bolt supplied in satin brass & dust box supplied matt black.

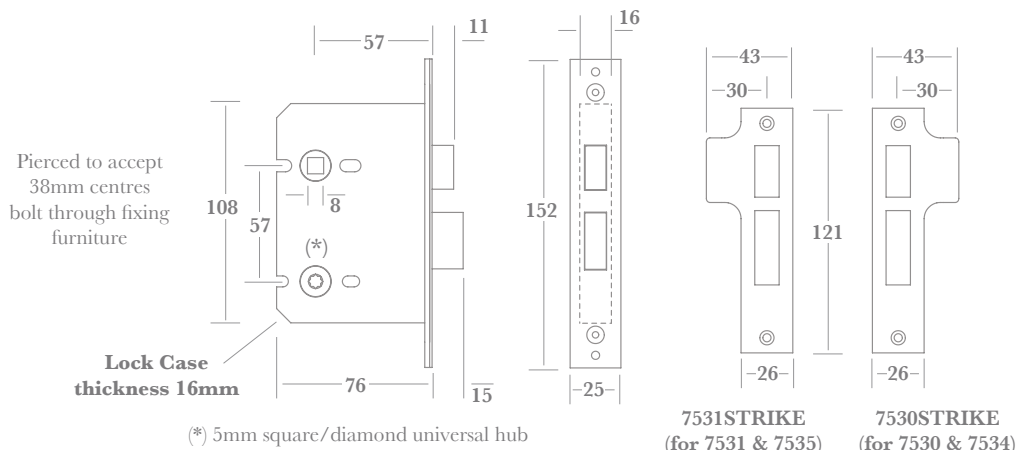

UK Spec	HANDING	CODE	ACTION
	LEFT	7530	light spring double action
	RIGHT	7531	light spring double action
	LEFT	7534	heavy spring single action
	RIGHT	7535	heavy spring single action

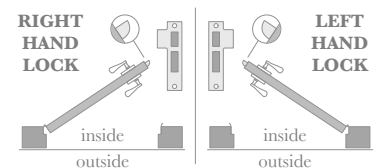

USA Spec	HANDING	CODE	ACTION
	RIGHT	7530	light spring double action
	LEFT	7531	light spring double action
	RIGHT	7534	heavy spring single action
	LEFT	7535	heavy spring single action

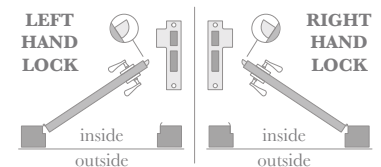

3 Lever Bit Key Lock

A 3 lever Bit Key Lock available with two latch spring strengths - 'light' for unsprung regular Knob Sets & sprung Lever Sets, and 'heavy' for unsprung Lever Sets & unsprung heavy Knob Sets, featuring a traditional handed Strike Plate supplied with a matt black Dust Box.

Strike & Face Plates along with cut head screws are supplied fully finish matched.



2 nickel plated keys supplied

7541 shown

▲ **7540/7541 Lock & Strike Set**

Light spring two-way action for unsprung regular Knob Sets & sprung Lever Sets.

7544/7545 Lock & Strike Set

Heavy spring single action for unsprung Lever Sets & unsprung heavy Knob Sets.

Fixings

Lock Case supplied with no.6 x 25mm zinc plated steel wood screws. Lock Case Face Plate supplied with M4 x 6mm finish matched machine screws. Strike Plate supplied with finish matched no.6 x 38mm wood screws.

Fixing packs available to be ordered separately - use code 01/026 (add finish)

Differs

100 standard differs with up to 500 available to special order.

How to Order

Lock & Strike Set:

- 1) select LOCK SET (e.g. **7540**)
- 2) add FINISH (e.g. **7540PC**)

Strike Plate only:

7541STRIKE - for 7541 & 7545

7540STRIKE - for 7540 & 7544

- 1) select STRIKE (e.g. **7540STRIKE**)
- 2) add FINISH (e.g. **7540STRIKE/PC**)

Finishes - See our price list or website for finish availability.

NB. Latch and Dead Bolt supplied in satin brass & dust box supplied matt black.

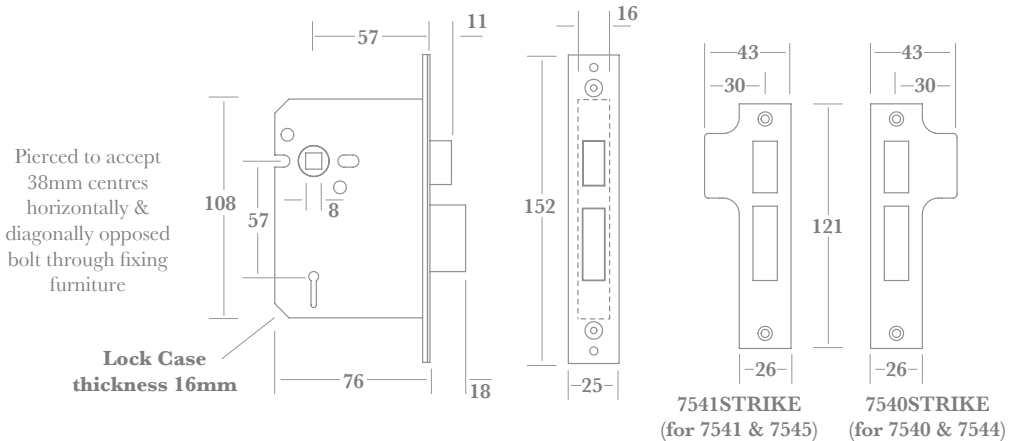

UK Specification	HANDING	CODE	ACTION
	LEFT	7540	light spring double action
	RIGHT	7541	light spring double action
	LEFT	7544	heavy spring single action
	RIGHT	7545	heavy spring single action

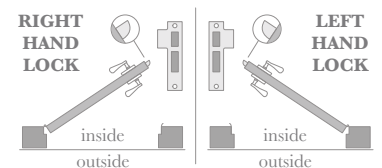

USA Specification	HANDING	CODE	ACTION
	RIGHT	7540	light spring double action
	LEFT	7541	light spring double action
	RIGHT	7544	heavy spring single action
	LEFT	7545	heavy spring single action

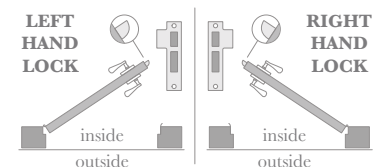

Sliding Door Lock

A Sliding Door Lock with Hook & Anti Lift Bar featuring a traditional Strike Plate.

Strike & Face Plates along with cut head screws are supplied fully finish matched.

A universal hub caters for either square or diamond orientated Turn spindles.



▲ 7560

Fixings

Lock Case supplied with no.6 x 25mm zinc plated steel wood screws. Lock Case Face Plate supplied with M4 x 6mm finish matched machine screws. Strike Plate supplied with finish matched no.6 x 38mm wood screws.

Fixing packs available to be ordered separately - use code 01/026 (add finish)

How to Order

1) add FINISH (e.g. 7560PC)

Finishes - See our price list or website for finish availability.

NB. Hook & Anti-lift Bar supplied in satin brass.

Lock Case thickness 16mm

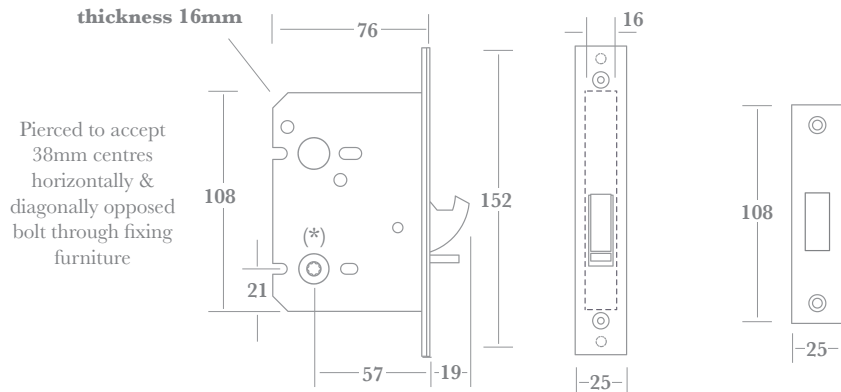

(*) 5mm square/diamond universal hub

Sliding Door Lock - with optional cylinder locking function

A multi-functional Sliding Door Lock with integrated, retractable, Pull Loop.

This Lock can be set up for either Cylinder & Turn, Turn & Release, or Turn only operation.

A particular feature is the finish matched Pull, Face Plate, Release Button, Strike Plate, and screws.



▲ 7565



Fixings

Lock Case supplied with no.6 x 25mm zinc plated steel wood screws. Lock Case Face Plate supplied with finish matched machine screws. Strike Plate supplied with finish matched no.6 x 38mm wood screws.

How to Order

1) add FINISH (e.g. 7565PC)

Finishes - See our price list or website for finish availability.

Lock Case thickness 18mm

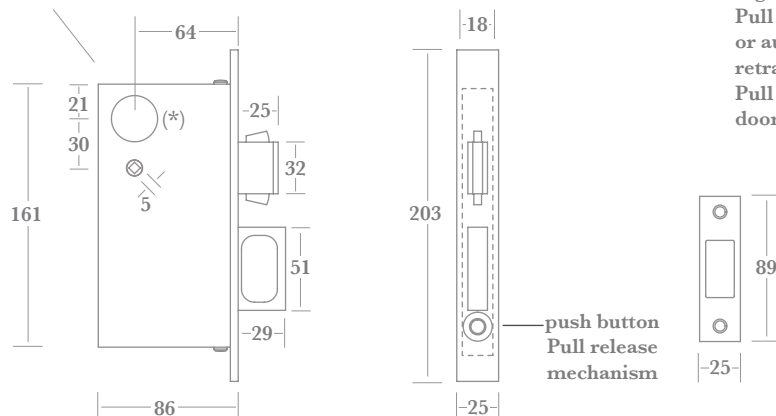

Light touch Pull retraction or automatic retraction when Pull contacts door frame.

(* the lock case takes any 1.15" mortise cylinder 32UNS-2B (not supplied)

Passage Latches & Privacy Deadbolts

A Tubular Passage Latch available with two latch spring strengths - 'light' for use with unsprung regular Knob Sets and sprung Lever Sets, and 'heavy' for use with unsprung Lever Sets & unsprung heavy Knob Sets, along with complementary Privacy Deadbolts; all available in five lengths/backsets, featuring traditional Strike Plates supplied with matt black dust boxes.

Strike & Face Plates along with cut head screws are supplied fully finish matched.



▲ **7500** (light springing - for use with unsprung regular Knob Sets & sprung Lever Sets)
 ▲ **7512** (heavy springing - for use with unsprung Lever Sets & unsprung heavy Knob Sets)



▲ **7555/7556**



▲ **7555** 5mm universal hub

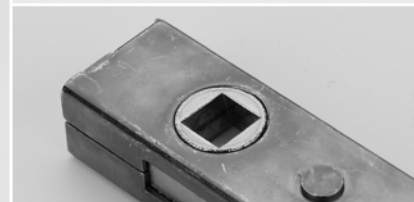

▲ **7556** 8mm square hub

Fixings

Supplied with finish matched no.6 x 25mm wood screws.

How to Order

- 1) select PRODUCT (e.g. **7512**)
- 2) add FINISH (e.g. **7512PC**)
- 3) add SIZE (e.g. **7512PC/C**).

Finishes - See our price list or website for finish availability.

NB. Latch supplied in satin brass & dust box supplied matt black.

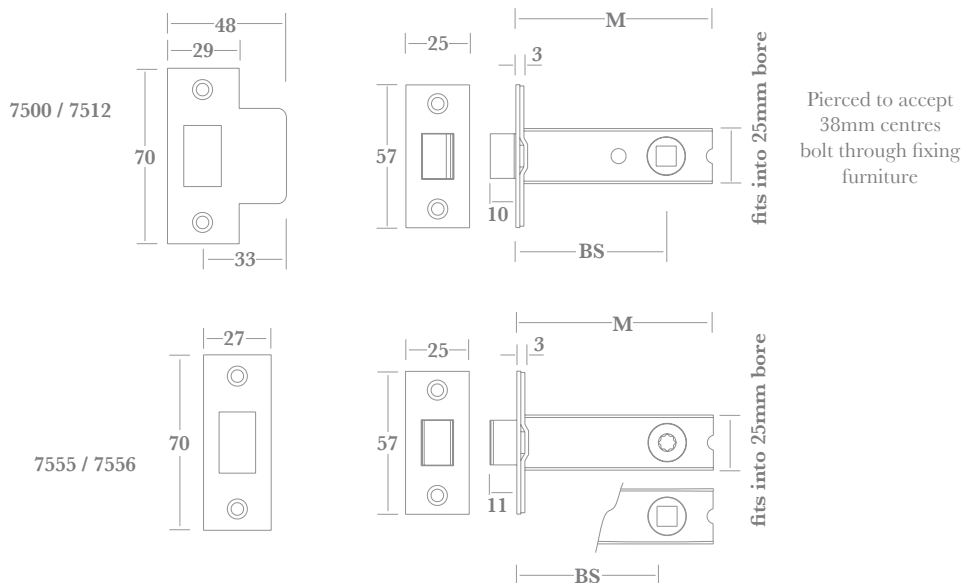

	A	B	C	D	E
BS (backset)	60	70	75	100	130
M (depth of mortice)	80	93	100	127	152

Rack Bolts

A solid brass Mortice Rack Bolt available in three lengths/backsets and offered in five configurations:

- Bolt & Strike Plate only;
- with Escutcheon Plate;
- with Key & Escutcheon Plate;
- with Oval Knob Turn; or
- with Oval Knob Turn & Coin Release.



▲ 0515



▲ 0516 (excluding Key)
0517 (including Key)



▲ 0525



▲ 0526



▲ to order separately use code 0517KEY

Fixings

Rack Bolts supplied with finish matched no.4 x 19mm wood screws.

Turns and Releases supplied with finish matched no.4 x 13mm wood screws.

How to Order

- 1) select BOLT (e.g. 0525)
- 2) add FINISH (e.g. 0525PC)
- 3) add SIZE (e.g. 0525PC/B).

Finishes - See our price list or website for finish availability.

Rack Bolts supplied with 0525 & 0526 are not available in all finishes (see below).

0517KEY supplied nickel plated only.

0525 & 0526 Rack Bolt Sets	
Finish ordered	Rack Bolt finish supplied
PGA/RG	IB
PG/PGU	PB
SG/SGU	SB
RGN	SN

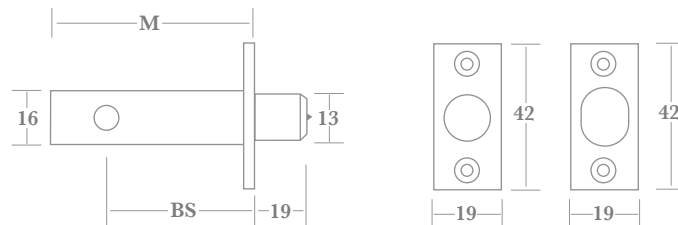

	A	B	C
BS (backset)	32	45	57
M (depth of mortice)	62	75	87

A 25mm backset version is available see page WF2:190

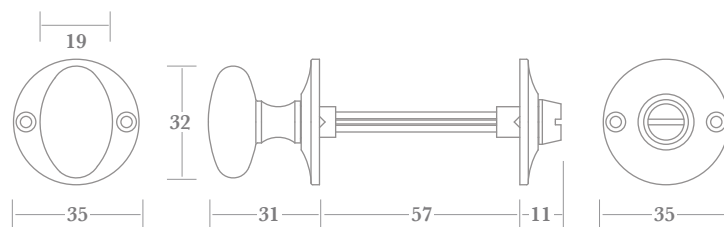

Turn & Releases available without Rack Bolts - see page DF6:010

max door thickness
(longer spindles available upon request)

Dead-Fixing Roller Latch

A novel Dead-Fixing Roller Latch incorporating a heavy duty, site adjustable, Roller Latch with a Dead-Fixing Slot suitable for both solid and pre-bored doors, featuring a traditional Strike Plate supplied with a matt black Dust Box.

Strike & Face Plates along with cut head screws are supplied fully finish matched.

This Latch is also suitable for installing into the top rail of a double door set for use in conjunction with fixed dead/dummy knobs & levers.



approx actual size

▲ 7804



solid door installation



▲ 8mm spindle inserted

▲ installed



pre-bored door installation



▲ 8mm spindle inserted

▲ installed

Fixings

Supplied with finish matched no.6 x 25mm wood screws.

How to Order

Add FINISH (c.g. 7804PC).

Finishes - See our price list or website for finish availability.

NB. Roller supplied in satin brass finish only & dust box supplied matt black.

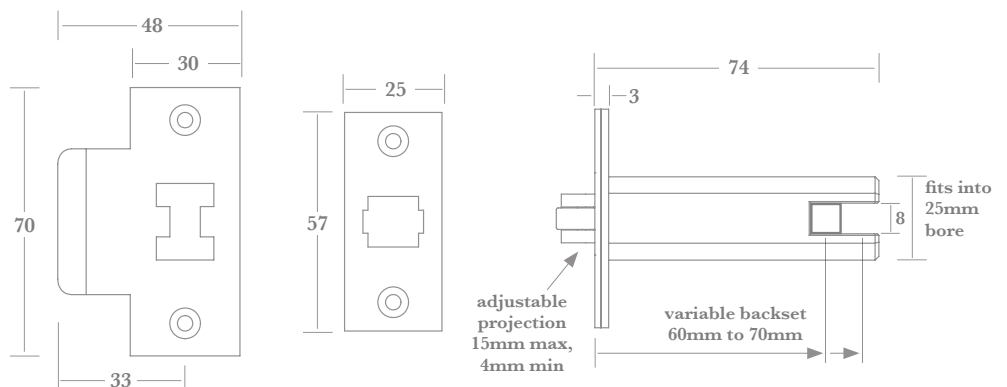

Fix-Dead Dummy Insert

A Fix-Dead Dummy Insert ideal for installation into either a solid or pre-bored door where no latching is required.

Face Plate along with cut head screws are supplied fully finish matched.



approx actual size

▲ 7802



solid door installation



▲ installed

▲ spindle inserted



pre-bored door installation



▲ installed

▲ spindle inserted

Fixings

Supplied with finish matched no.6 x 25mm wood screws.

How to Order

1) Add FINISH (e.g. 7802PC)

Finishes - See our price list or website for finish availability.

NB. Dummy Insert supplied in mill finish brass.

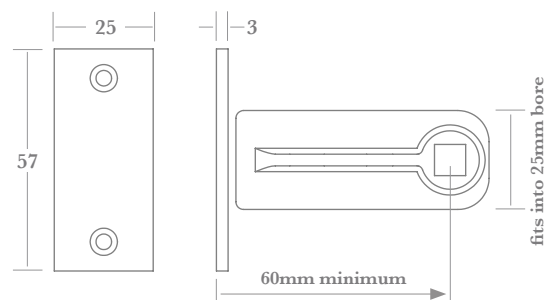

Fasteners

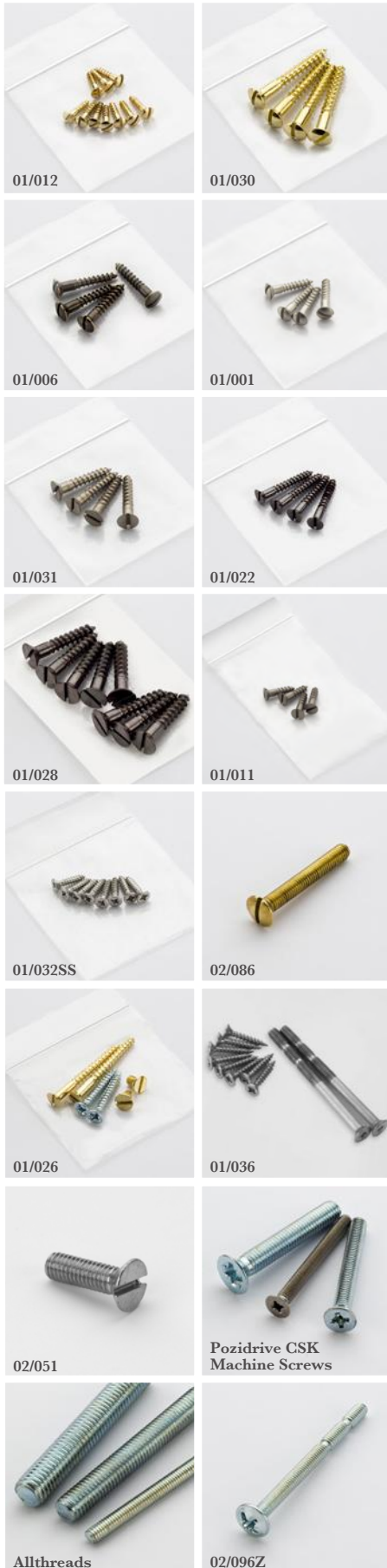

Code	Size	Number per pack	Finishes available
Raised CSK Wood Screw Packs			
01/018	no.4 x 13mm	4	Available in finishes except Stainless Steel & Zinc Plated Steel
01/012	no.4 x 13mm	10	
01/029	no.4 x 19mm	6	
01/020	no.6 x 16mm	6	
01/001	no.6 x 19mm	4	
01/002	no.6 x 19mm	6	
01/003	no.6 x 25mm	4	
01/004	no.6 x 25mm	6	
01/005	no.6 x 32mm	4	
01/006	no.8 x 25mm	4	
01/007	no.8 x 25mm	6	
01/014	no.8 x 32mm	4	
01/015	no.8 x 32mm	6	
01/030	no.10 x 38mm	4	
Flat CSK Wood Screw Packs			
01/011	no.4 x 13mm	4	Available in finishes except Stainless Steel & Zinc Plated Steel
01/017	no.4 x 19mm	8	
01/016	no.4 x 25mm	10	
01/035	no.6 x 19mm	4	
01/022	no.6 x 25mm	4	
01/031	no.8 x 25mm	4	
01/028	no.12 x 32mm	8	
Pozidrive CSK Wood Screw Pack			
01/032SS	no.4 x 13mm	8	Stainless Steel only
Raised CSK Machine Screws			
02/016	M3.5 x 12mm	1	Available in finishes except Stainless Steel & Zinc Plated Steel
02/023	M5 x 35mm	1	
02/086	M5 x 40mm	1	
Multi-Screw Packs			
01/026	no.6 x 38mm CSK	2	Available in finishes except Stainless Steel & Zinc Plated Steel (*) Stainless Steel only
	M4 x 6mm CSK	2	
	no.6 x 25mm Pozidrive CSK twin threads (*)	2	
01/036	no.6 x 19mm Pozidrive CSK	8	Stainless Steel only
	M5 x 70mm break-off M/c screw	2	
Flat CSK Slotted Machine Screws			
02/051	M3 x 10mm		Available in finishes except Stainless Steel & Zinc Plated Steel
02/053	M4 x 12mm	1	
02/044	M5 x 10mm	1	
Flat CSK Pozidrive Machine Screws			
02/026SS	M4 x 12mm	1	Stainless Steel only
02/094SS	M5 x 50mm	1	Stainless Steel only
02/040Z	M6 x 50mm	1	Zinc Plated Steel only
02/039Z	M8 x 50mm	1	Zinc Plated Steel only
Allthreads			
14/024Z	M6 x 75mm	1	Zinc Plated Steel only
14/022Z	M10 x 75mm	1	
14/023Z	M12 x 75mm	1	
Flange Head Machine Screws			
02/096Z	M4 x 50mm	1	Zinc Plated Steel only

<p>▲ 11/005R (2089 & 2117 Door Stops)</p>	<p>▲ 11/001R (2112 & 2114 Door Stops)</p>	<p>▲ 11/027R (2122 Door Stop)</p>	<p>▲ 11/002R (2115, 2119, 2120 & 2126 Door Stops)</p>
<p>Assembly rivet included</p> <p>▲ 11/003R (2118 & 2123 Door Stops)</p>	<p>▲ 11/006R (2111 Door Stop)</p>	<p>▲ 11/028R (2125 Door Stop)</p>	<p>▲ 11/029R (2130 type Door Stops)</p>
<p>▲ 05/033N Allart Select Shoulder Washer</p>	<p>▲ 05/031N Traditional Lever/ Knob Shoulder Washer</p>	<p>▲ 10/001S 9mm Star Lock Washer</p>	<p>▲ 09/001S Circlip for Lever/Knob assembly</p>
<p>▲ 04/024(add finish) Slotted M5 Blind Nuts</p>	<p>(RH) (LH)</p> <p>▲ 06/014S (LH) 06/013S (RH) Door Lever Springs</p>	<p>▲ B7600KEY M5 Allen Key</p>	<p>▲ B7601KEY M6 Allen Key</p>
<p>▲ 20/033SS M6 x 8mm Grubscrew</p>	<p>▲ 20/021SS M5 x 8mm Grubscrew</p>	<p>▲ 02/087Z M4 x 25mm Dowel Screw</p>	